

User Manual

Pet immunity PIR intrusion detector BP-PIR01



Enjoy it.

1. Introduction

BP-PIR01 is a passive infrared intrusion detector for detecting accidental or malicious intrusion, to meet a demand for your protection. The design for the small size round white stained flow line shape, can be installed on the wall or a 45° angle with the wall installation, ideal installation height is 1.8m-2.4m from the ground under the protection zone can be avoided, as the protective corners, you can set the sensitivity to accommodate the installation environment. This product has a built-in tamper switch to prevent unauthorized removal.

This product can be widely used in homes, shops, banks, offices, warehouses, garages and other places.

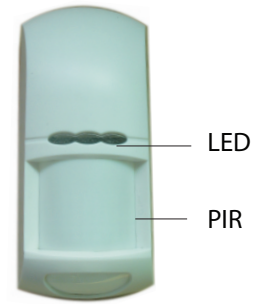

Fig. 1 overall view

2. Specifications

Model: BP-PIR01
Detection range: 12m(25°)
Input voltage : 12VDC
Quiescent Current : 15mA
infrared range(as shown in right figure)

Alarm and tamper switch
Alarm output: Solid relay,NC.
less 100mA/30V,--10Ω internal impedance
tamper switch: N.C.,50mA/30VDC
less100mA/30V,--10Ω internal impedance

Alarm indication: LED light alarm

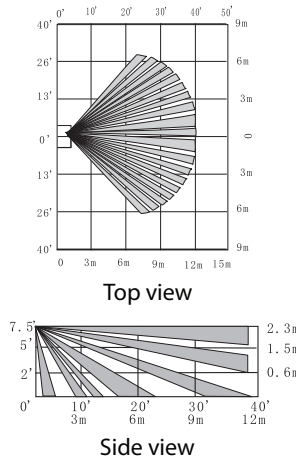

Installation:
 Wall or corner installation, the installation height of 1.8-2.4 meters (6-8 feet) from the ground
Note: The single side of the base to wall at 45 degree is allowed.

Working environment:
Working temperature: -10°C -50°C (14°F-122°F)
Storage: -20°C -60°C (-4°F-140°F)
Anti-white light(indoor): > 6500LUX
Anti-emi: 30V /m, 10MHz-1000MHz
Size :(L*W*H)125*74*43 mm

3. Installation

3.1 General Guidelines

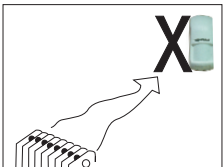

Don not face cool or heat source directly

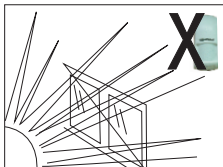

Don not face the sunshine directly

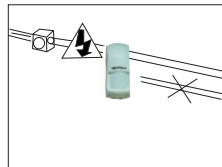

Wire connection or detector should be away from High voltage cable

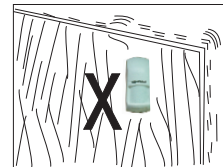

Don not install on unstable object



Don not install facing the metal wall

3.2 Pet-immunity manual

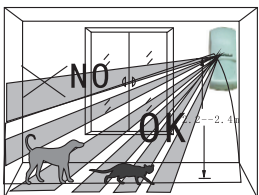

The top part of detection area in non pet-immunity area

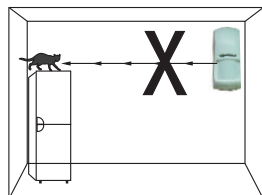

Never face the detector to the place that pets can climb up directly

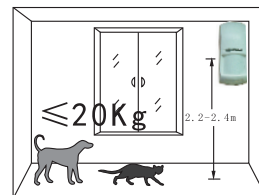

Pet immunity: ≤20kg pets

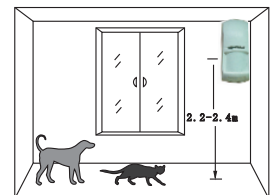

Pet immunity installation height: 2.2 - 2.4M

3.3 Installation

1. Disassemble procedure:

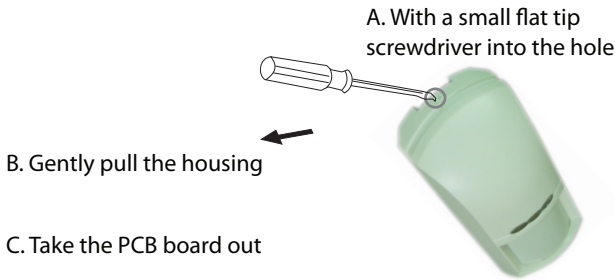

2. Installed base: 1.8 - 2.4 meters (6-8 feet) from the ground

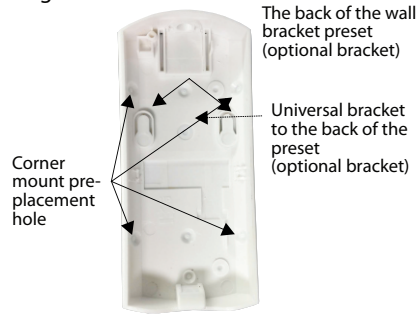

- A. Mark the drill point and drill a hole in the wall
- B. Pull wire from back slot into base
- C. Insert two screws, and the base with two screws to the wall
- D. Press the PCB board into the buckle tightly

3.4 DIP Switches function

	ON	OFF
1	N.O.	N.C.
2	LOW	HIGH
3	LED ON	LED OFF

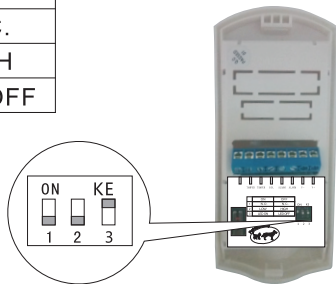

3.5 Indicators



3.6 Terminal connection

1. The anti-dismantling method is not connected

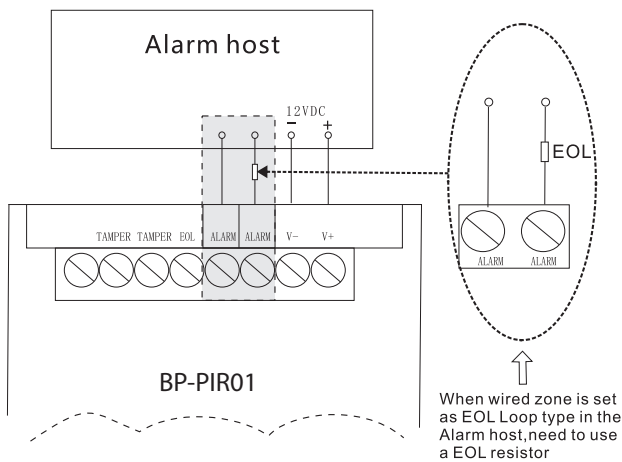

2. Access tamper-proof connection method

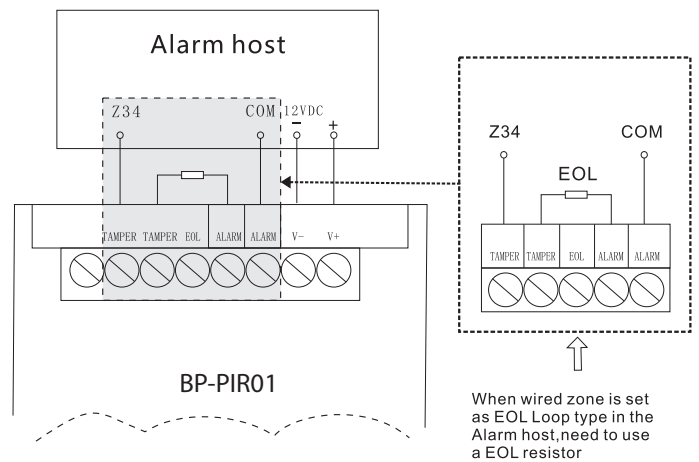

3.7 Walk-test on the coverage area

Assemble the front cover (as shown in figure)

- A. Electrify and self-check then start walk-test.
 - B. Walk across the end of coverage area, the indicator LED should light red for 2-3 seconds.
 - C. Do walk-test in opposite direction to confirm the boundary of both sides. make sure the detection centre pointing to the centre of protected area.
 - D. Slowly put hands up the detection area where 3-6 meters away from the detector and mark the bottom border of the PIR alarm. Repeat to confirm the top border.
 - E. Make sure the detection centre at the proper place. Should properly adjust the detection area if you can not get an ideal detection range.
- Important: To ensure continued good probe function, it is recommended once a month to walk test the detector

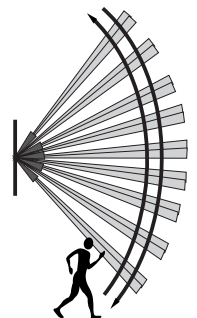

4. Customer service

Our products are very reliable, but for some special reasons, the working performance will be limited in certain range. We here list some cases as follows:

- 1. The voltage of control panel is not stable
- 2. Low-voltage of the detector.

For any help please contact with our company and you could visit our website for more information.

Warning: we are not responsible for the problem caused by incorrect operation by users.

For Inquiries, Please contact:

Security Shop
Vladimira Popovica 6/6/A606
11070 Novi Beograd, Serbia
Tell: +381 11 318 68 68
office@securityshop.rs

Imported/Distributed by Security Shop doo
license of Blaupunkt
www.blaupunkt.com
Made in China